

1.8-V OPERATIONAL AMPLIFIERS WITH RAIL-TO-RAIL INPUT AND OUTPUT

Check for Samples: [LMV931-Q1](#), [LMV932-Q1](#), [LMV934-Q1](#)

FEATURES

- Qualified for Automotive Applications
- 1.8-V, 2.7-V, and 5-V Specifications
- Rail-to-Rail Output Swing
 - 600-Ω Load: 80 mV From Rail
 - 2-kΩ Load: 30 mV From Rail
- V_{ICR} : 200 mV Beyond Rails
- Gain Bandwidth: 1.4 MHz
- Supply Current: 100 μA/Amplifier
- Max V_{IO} : 4 mV
- Space-Saving Packages
 - LMV931: SOT-23 and SC-70
 - LMV932: SOIC
 - LMV934: SOIC

APPLICATIONS

- Industrial (Utility/Energy Metering)
- Automotive
- Communications (Optical Telecom, Data/Voice Cable Modems)
- Consumer Electronics (PDAs, PCs, CD-R/W, Portable Audio)
- Supply-Current Monitoring
- Battery Monitoring

DESCRIPTION

The LMV93x devices are low-voltage low-power operational amplifiers that are well suited for today's low-voltage and/or portable applications. Specified for operation of 1.8 V to 5 V, they can be used in portable applications that are powered from a single-cell Li-ion or two-cell batteries. They have rail-to-rail input and output capability for maximum signal swings in low-voltage applications. The LMV93x input common-mode voltage extends 200 mV beyond the rails for increased flexibility. The output can swing rail-to-rail unloaded and typically can reach 80 mV from the rails, while driving a 600-Ω load (at 1.8-V operation).

During 1.8-V operation, the devices typically consume a quiescent current of 103 μA per channel, and yet they are able to achieve excellent electrical specifications, such as 101-dB open-loop DC gain and 1.4-MHz gain bandwidth. Furthermore, the amplifiers offer good output drive characteristics, with the ability to drive a 600-Ω load and 1000-pF capacitance with minimal ringing.

The LMV93x devices are offered in the latest packaging technology to meet the most demanding space-constraint applications. The LMV931 is offered in standard SOT-23 and SC-70 packages. The LMV932 is available in the traditional SOIC package. The LMV934 is available in the traditional SOIC package and the TSSOP package.

The LMV93x devices are characterized for operation from –40°C to 125°C, making the part universally suited for commercial, industrial, and automotive applications.

LMV931...DBV (SOT-23-5) OR DCK (SC-70) PACKAGE
(TOP VIEW)

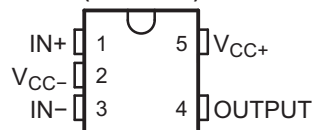

LMV932...D (SOIC) PACKAGE
(TOP VIEW)

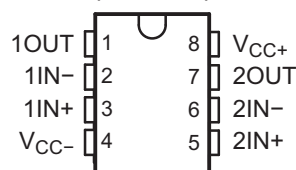

LMV934...D (SOIC) OR PW (TSSOP) PACKAGE
(TOP VIEW)

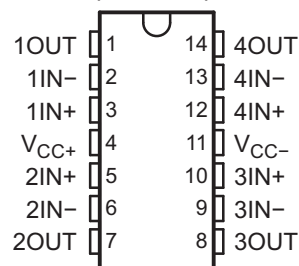

Please be aware that an important notice concerning availability, standard warranty, and use in critical applications of Texas Instruments semiconductor products and disclaimers thereto appears at the end of this data sheet.

ORDERING INFORMATION⁽¹⁾

T _A	PACKAGE ⁽²⁾		ORDERABLE PART NUMBER	TOP-SIDE MARKING ⁽³⁾	
-40°C to 125°C	Single	SOT-23 – DBV	Reel of 3000	LMV931QDBVRQ1	RBB_
		SC-70 – DCK	Reel of 3000	LMV931QDCKRQ1	RB_
	Quad	SOIC – D	Reel of 2500	LMV932QDRQ1	MV932Q
		SOIC – D	Reel of 2500	LMV934QDRQ1	LMV934Q
		TSSOP – PW	Reel of 2000	LVM934QPWRQ1	LMV934Q

- (1) For the most current package and ordering information, see the Package Option Addendum at the end of this document, or see the TI web site at www.ti.com.
- (2) Package drawings, thermal data, and symbolization are available at www.ti.com/packaging.
- (3) DBV/DCK: The actual top-side marking has one additional character that designates the wafer fab/assembly site.

SIMPLIFIED SCHEMATIC

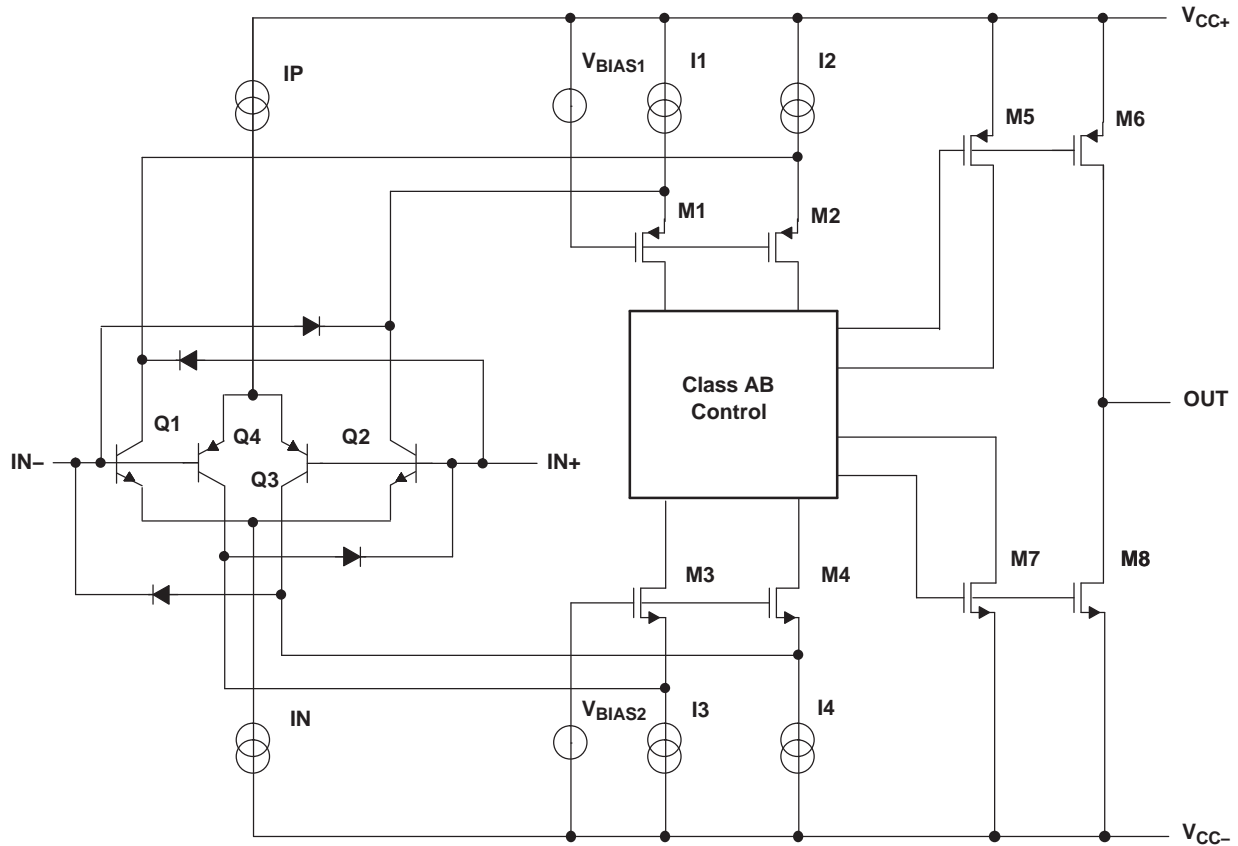

ABSOLUTE MAXIMUM RATINGS⁽¹⁾

over free-air temperature range (unless otherwise noted)

		MIN	MAX	UNIT
$V_{CC+} - V_{CC-}$	Supply voltage ⁽²⁾		5.5	V
V_{ID}	Differential input voltage ⁽³⁾	Supply voltage		
V_I	Input voltage range, either input	$V_{CC-} - 0.2$	$V_{CC+} + 0.2$	V
	Duration of output short circuit (one amplifier) to $V_{CC\pm}$ ^{(4) (5)}	Unlimited		
θ_{JA}	Package thermal impedance ^{(5) (6)}	D package (8 pin)	97	°C/W
		D package (14 pin)	86	
		DBV package	206	
		DCK package	252	
		PW package	112.6	
T_J	Operating virtual junction temperature		150	°C
T_{stg}	Storage temperature range	-65	150	°C

- (1) Stresses beyond those listed under *Absolute Maximum Ratings* may cause permanent damage to the device. These are stress ratings only, and functional operation of the device at these or any other conditions beyond those indicated under *Recommended Operating Conditions* is not implied. Exposure to absolute-maximum-rated conditions for extended periods may affect device reliability.
- (2) All voltage values (except differential voltages and V_{CC} specified for the measurement of I_{OS}) are with respect to the network GND.
- (3) Differential voltages are at IN+ with respect to IN-.
- (4) Applies to both single-supply and split-supply operation. Continuous short-circuit operation at elevated ambient temperature can result in exceeding the maximum allowed junction temperature of 150°C. Output currents in excess of 45 mA over long term may adversely affect reliability.
- (5) Maximum power dissipation is a function of $T_J(\max)$, θ_{JA} , and T_A . The maximum allowable power dissipation at any allowable ambient temperature is $P_D = (T_J(\max) - T_A)/\theta_{JA}$. Operating at the absolute maximum T_J of 150°C can affect reliability.
- (6) The package thermal impedance is calculated in accordance with JESD 51-7.

RECOMMENDED OPERATING CONDITIONS

		MIN	MAX	UNIT
V_{CC}	Supply voltage ($V_{CC+} - V_{CC-}$)	1.8	5	V
T_A	Operating free-air temperature	-40	125	°C

ESD PROTECTION

		TYP	UNIT
Human-Body Model		2000	V
Machine Model		200	V
Charged-Device Model	LMV934QPWRQ1	All pins	500
		Corner Pins	750

ELECTRICAL CHARACTERISTICS

$V_{CC+} = 1.8\text{ V}$, $V_{CC-} = 0\text{ V}$, $V_{IC} = V_{CC+}/2$, $V_O = V_{CC+}/2$, $R_L > 1\text{ M}\Omega$ (unless otherwise noted)

PARAMETER		TEST CONDITIONS		T_A	MIN	TYP	MAX	UNIT	
V_{IO}	Input offset voltage	LMV931 (single)		25°C		1	4	mV	
				Full range			6		
		LMV932 (dual), LMV934 (quad)		25°C		1	5.5		
				Full range			7.5		
α_{VIO}	Average temperature coefficient of input offset voltage			25°C		5.5		$\mu\text{V}/^\circ\text{C}$	
I_{IB}	Input bias current			25°C		15	35	nA	
				25°C			65		
				Full range			75		
I_{IO}	Input offset current			25°C		13	25	nA	
				Full range			40		
I_{CC}	Supply current (per channel)			25°C		103	185	μA	
				Full range			205		
$CMRR$	Common-mode rejection ratio			25°C	60	78		dB	
				-40°C to 85°C	55				
				-40°C to 125°C	55				
k_{SVR}	Supply-voltage rejection ratio			25°C	72	100		dB	
				Full range	65				
V_{ICR}	Common-mode input voltage range		CMRR $\geq 50\text{ dB}$	25°C	$V_{CC-} - 0.2$	-0.2 to 2.1	$V_{CC+} + 0.2$	V	
				-40°C to 85°C	V_{CC-}		V_{CC+}		
				-40°C to 125°C	$V_{CC-} + 0.2$		$V_{CC+} - 0.2$		
A_V	Large-signal voltage gain	LMV931	$V_O = 0.2\text{ V to }1.6\text{ V}$, $V_{IC} = 0.5\text{ V}$	$R_L = 600\ \Omega$ to 0.9 V	25°C	77	101	dB	
				Full range	73				
		$R_L = 2\text{ k}\Omega$ to 0.9 V		25°C	80	105			
		Full range		75					
		LMV932, LMV934		$R_L = 600\ \Omega$ to 0.9 V	25°C	75	90		
				Full range	72				
V_O	Output swing	$R_L = 600\ \Omega$ to 0.9 V, $V_{ID} = \pm 100\text{ mV}$		High level	25°C	1.65	1.72	V	
					Full range	1.63			
				Low level	25°C		0.077		0.105
					Full range				0.120
		$R_L = 2\text{ k}\Omega$ to 0.9 V, $V_{ID} = \pm 100\text{ mV}$		High level	25°C	1.75	1.77		
					Full range	1.74			
				Low level	25°C		0.024		0.035
					Full range				0.040
I_{OS}	Output short-circuit current	$V_O = 0\text{ V}$, $V_{ID} = 100\text{ mV}$	Sourcing	25°C	4	8	mA		
				Full range	3.3				
		$V_O = 1.8\text{ V}$, $V_{ID} = -100\text{ mV}$	Sinking	25°C	7	9			
				Full range	5				
GBW	Gain bandwidth product			25°C		1.4		MHz	

ELECTRICAL CHARACTERISTICS (continued)
 $V_{CC+} = 1.8\text{ V}$, $V_{CC-} = 0\text{ V}$, $V_{IC} = V_{CC+}/2$, $V_O = V_{CC+}/2$, $R_L > 1\text{ M}\Omega$ (unless otherwise noted)

PARAMETER	TEST CONDITIONS	T_A	MIN	TYP	MAX	UNIT
SR	Slew rate ⁽¹⁾	25°C		0.35		V/ μ s
Φ_m	Phase margin	25°C		67		°
	Gain margin	25°C		7		dB
V_n	Equivalent input noise voltage	$f = 1\text{ kHz}$, $V_{IC} = 0.5\text{ V}$		60		nV/ $\sqrt{\text{Hz}}$
I_n	Equivalent input noise current	$f = 1\text{ kHz}$		0.06		pA/ $\sqrt{\text{Hz}}$
THD	Total harmonic distortion	$f = 1\text{ kHz}$, $A_V = 1$, $R_L = 600\ \Omega$, $V_{ID} = 1\text{ V}_{p-p}$		0.023		%
	Amplifier-to-amplifier isolation ⁽²⁾	25°C		123		dB

(1) Number specified is the slower of the positive and negative slew rates.

(2) Input referred, $V_{CC+} = 5\text{ V}$ and $R_L = 100\text{ k}\Omega$ connected to 2.5 V. Each amplifier is excited, in turn, with a 1-kHz signal to produce $V_O = 3\text{ V}_{p-p}$.

ELECTRICAL CHARACTERISTICS

$V_{CC+} = 2.7\text{ V}$, $V_{CC-} = 0\text{ V}$, $V_{IC} = V_{CC+}/2$, $V_O = V_{CC+}/2$, and $R_L > 1\text{ M}\Omega$ (unless otherwise noted)

PARAMETER		TEST CONDITIONS		T_A	MIN	TYP	MAX	UNIT
V_{IO}	Input offset voltage	LMV931 (single)		25°C		1	4	mV
				Full range			6	
		LMV932 (dual), LMV934 (quad)		25°C		1	5.5	
				Full range			7.5	
α_{VIO}	Average temperature coefficient of input offset voltage			25°C		5.5		$\mu\text{V}/^\circ\text{C}$
I_{IB}	Input bias current			25°C		15	35	nA
				25°C			65	
				Full range			75	
I_{IO}	Input offset current			25°C		8	25	nA
				Full range			40	
I_{CC}	Supply current (per channel)			25°C		105	190	μA
				Full range			210	
CMRR	Common-mode rejection ratio			25°C	60	81		dB
				-40°C to 85°C	55			
				-40°C to 125°C	55			
k_{SVR}	Supply-voltage rejection ratio			25°C	72	100		dB
				Full range	65			
V_{ICR}	Common-mode input voltage range		CMRR $\geq 50\text{ dB}$	25°C	$V_{CC-} - 0.2$	$-0.2\text{ to }3$	$V_{CC+} + 0.2$	V
				-40°C to 85°C	V_{CC-}		V_{CC+}	
				-40°C to 125°C	$V_{CC-} + 0.2$		$V_{CC+} - 0.2$	
A_V	Large-signal voltage gain	LMV931	$V_O = 0.2\text{ V to }2.5\text{ V}$	$R_L = 600\ \Omega$ to 1.35 V	25°C	87	104	dB
				Full range	86			
		$R_L = 2\text{ k}\Omega$ to 1.35 V		25°C	92	110		
		Full range		91				
		LMV932, LMV934		$R_L = 600\ \Omega$ to 1.35 V	25°C	78	90	
				Full range	75			
V_O	Output swing		$R_L = 600\ \Omega$ to 1.35 V , $V_{ID} = \pm 100\text{ mV}$	High level	25°C	2.55	2.62	V
				Full range	2.53			
		Low level		25°C		0.083	0.11	
		Full range				0.13		
				High level	25°C	2.65	2.675	
				Full range	2.64			
I_{OS}	Output short-circuit current	$V_O = 0\text{ V}$, $V_{ID} = 100\text{ mV}$		Sourcing	25°C	20	30	mA
				Full range	15			
		$V_O = 2.7\text{ V}$, $V_{ID} = -100\text{ mV}$		Sinking	25°C	18	25	
				Full range	12			
GBW	Gain bandwidth product			25°C		1.4		MHz

ELECTRICAL CHARACTERISTICS (continued)
 $V_{CC+} = 2.7\text{ V}$, $V_{CC-} = 0\text{ V}$, $V_{IC} = V_{CC+}/2$, $V_O = V_{CC+}/2$, and $R_L > 1\text{ M}\Omega$ (unless otherwise noted)

PARAMETER	TEST CONDITIONS	T_A	MIN	TYP	MAX	UNIT
SR	Slew rate ⁽¹⁾	25°C		0.4		V/ μ s
Φ_m	Phase margin	25°C		70		°
	Gain margin	25°C		7.5		dB
V_n	Equivalent input noise voltage	$f = 1\text{ kHz}$, $V_{IC} = 0.5\text{ V}$		57		nV/ $\sqrt{\text{Hz}}$
I_n	Equivalent input noise current	$f = 1\text{ kHz}$		0.082		pA/ $\sqrt{\text{Hz}}$
THD	Total harmonic distortion	$f = 1\text{ kHz}$, $A_V = 1$, $R_L = 600\ \Omega$, $V_{ID} = 1\text{ V}_{p-p}$		0.022		%
	Amplifier-to-amplifier isolation ⁽²⁾	25°C		123		dB

(1) Number specified is the slower of the positive and negative slew rates.

(2) Input referred, $V_{CC+} = 5\text{ V}$ and $R_L = 100\text{ k}\Omega$ connected to 2.5 V. Each amplifier is excited, in turn, with a 1-kHz signal to produce $V_O = 3\text{ V}_{p-p}$.

ELECTRICAL CHARACTERISTICS

$V_{CC+} = 5\text{ V}$, $V_{CC-} = 0\text{ V}$, $V_{IC} = V_{CC+}/2$, $V_O = V_{CC+}/2$, and $R_L > 1\text{ M}\Omega$ (unless otherwise noted)

PARAMETER		TEST CONDITIONS		T_A	MIN	TYP	MAX	UNIT	
V_{IO}	Input offset voltage	LMV931 (single)		25°C		1	4	mV	
				Full range			6		
		LMV932 (dual), LMV934 (quad)		25°C		1	5.5		
				Full range			7.5		
α_{VIO}	Average temperature coefficient of input offset voltage			25°C		5.5		$\mu\text{V}/^\circ\text{C}$	
I_{IB}	Input bias current	$V_{IC} = V_{CC+} - 0.8\text{ V}$		25°C		15	35	nA	
				25°C			65		
				Full range			75		
I_{IO}	Input offset current			25°C		9	25	nA	
				Full range			40		
I_{CC}	Supply current (per channel)	LMV931		25°C		116	210	μA	
				Full range			230		
		LMV932, LMV934		25°C		116	225		
				Full range			275		
CMRR	Common-mode rejection ratio			25°C	60	86		dB	
				-40°C to 85°C	55				
				-40°C to 125°C	55				
k_{SVR}	Supply-voltage rejection ratio	$1.8\text{ V} \leq V_{CC+} \leq 5\text{ V}$, $V_{IC} = 0.5\text{ V}$		25°C	72	100		dB	
				Full range	65				
V_{ICR}	Common-mode input voltage range	CMRR $\geq 50\text{ dB}$		25°C	$V_{CC-} - 0.2$	-0.2 to 5.3	$V_{CC+} + 0.2$	V	
				-40°C to 85°C	V_{CC-}		V_{CC+}		
				-40°C to 125°C	$V_{CC-} + 0.3$		$V_{CC+} - 0.3$		
A_V	Large-signal voltage gain	LMV931	$V_O = 0.2\text{ V to } 4.8\text{ V}$	$R_L = 600\ \Omega$ to 2.5 V	25°C	88	102	dB	
					Full range	87			
				$R_L = 2\text{ k}\Omega$ to 2.5 V	25°C	94	113		
					Full range	93			
				LMV932, LMV934	$R_L = 600\ \Omega$ to 2.5 V	25°C	81		90
						Full range	78		
$R_L = 2\text{ k}\Omega$ to 2.5 V	25°C	85	100						
	Full range	82							
V_O	Output swing	$R_L = 600\ \Omega$ to 2.5 V, $V_{ID} = \pm 100\text{ mV}$	High level	25°C	4.855	4.89		V	
				Full range	4.835				
			Low level	25°C		0.12	0.16		
				Full range			0.18		
		$R_L = 2\text{ k}\Omega$ to 2.5 V, $V_{ID} = \pm 100\text{ mV}$	High level	25°C	4.945	4.967			
				Full range	4.935				
			Low level	25°C		0.037	0.065		
				Full range			0.075		

ELECTRICAL CHARACTERISTICS (continued)
 $V_{CC+} = 5\text{ V}$, $V_{CC-} = 0\text{ V}$, $V_{IC} = V_{CC+}/2$, $V_O = V_{CC+}/2$, and $R_L > 1\text{ M}\Omega$ (unless otherwise noted)

PARAMETER		TEST CONDITIONS		T_A	MIN	TYP	MAX	UNIT
I_{OS}	Output short-circuit current	LMV931	$V_O = 0\text{ V}$, $V_{ID} = 100\text{ mV}$	Sourcing	25°C	80	100	mA
					Full range	68		
		LMV932, LMV934	$V_O = 5\text{ V}$, $V_{ID} = -100\text{ mV}$	Sinking	25°C	58	65	
					Full range	45		
		LMV932, LMV934	$V_O = 0\text{ V}$, $V_{ID} = 100\text{ mV}$	Sourcing	25°C	75	100	
					Full range	68		
LMV932, LMV934	$V_O = 5\text{ V}$, $V_{ID} = -100\text{ mV}$	Sinking	25°C	50	65			
			Full range		60			
GBW	Gain bandwidth product			25°C		1.5		MHz
SR	Slew rate ⁽¹⁾			25°C		0.42		V/ μ s
Φ_m	Phase margin			25°C		71		°
	Gain margin			25°C		8		dB
V_n	Equivalent input noise voltage	$f = 1\text{ kHz}$, $V_{IC} = 0.5\text{ V}$		25°C		50		nV/ $\sqrt{\text{Hz}}$
I_n	Equivalent input noise current	$f = 1\text{ kHz}$		25°C		0.07		pA/ $\sqrt{\text{Hz}}$
THD	Total harmonic distortion	$f = 1\text{ kHz}$, $A_V = 1$, $R_L = 600\ \Omega$, $V_{ID} = 1\text{ V}_{p-p}$		25°C		0.022		%
	Amplifier-to-amplifier isolation ⁽²⁾			25°C		123		dB

(1) Number specified is the slower of the positive and negative slew rates.

(2) Input referred, $V_{CC+} = 5\text{ V}$ and $R_L = 100\text{ k}\Omega$ connected to 2.5 V. Each amplifier is excited, in turn, with a 1-kHz signal to produce $V_O = 3\text{ V}_{p-p}$.

TYPICAL CHARACTERISTICS

$V_{CC+} = 5\text{ V}$, Single Supply, $T_A = 25^\circ\text{C}$ (unless otherwise specified)

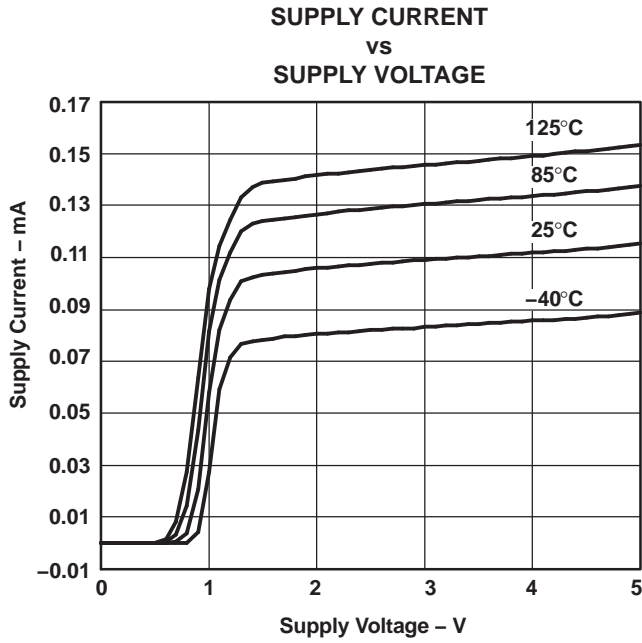

Figure 1.

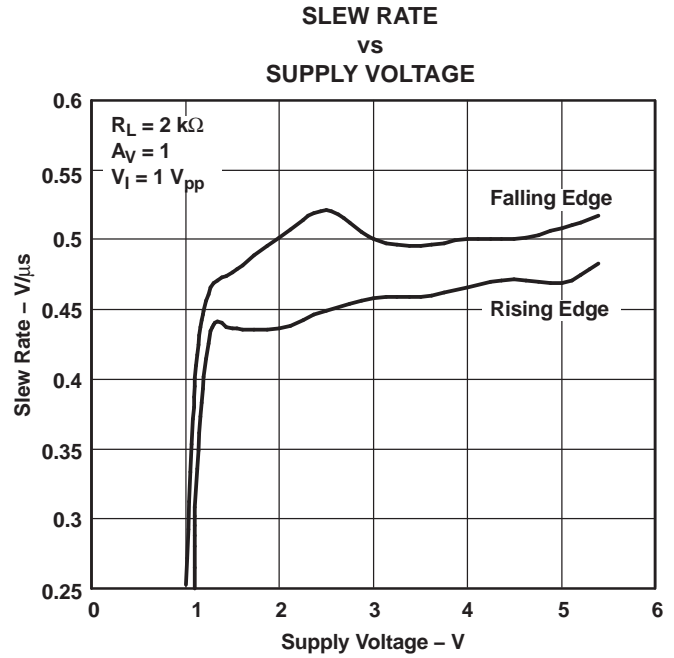

Figure 2.

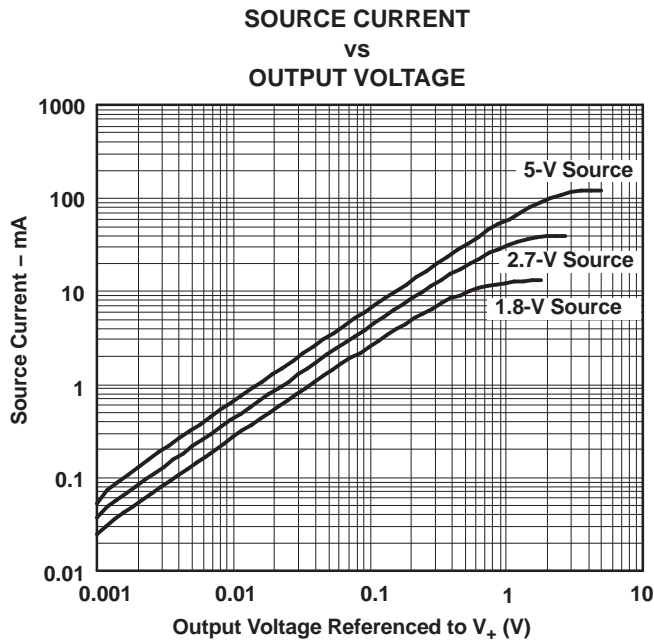

Figure 3.

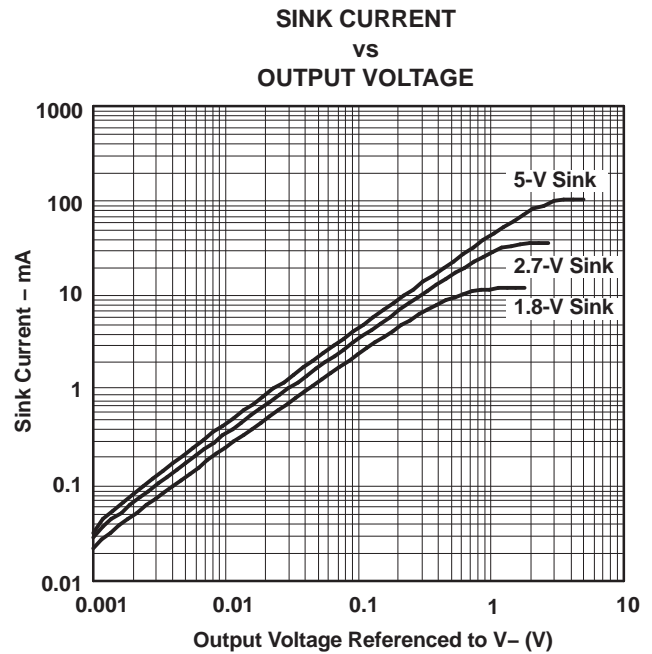

Figure 4.

TYPICAL CHARACTERISTICS (continued)

V_{CC+} = 5 V, Single Supply, T_A = 25°C (unless otherwise specified)

**OUTPUT VOLTAGE SWING
vs
SUPPLY VOLTAGE**

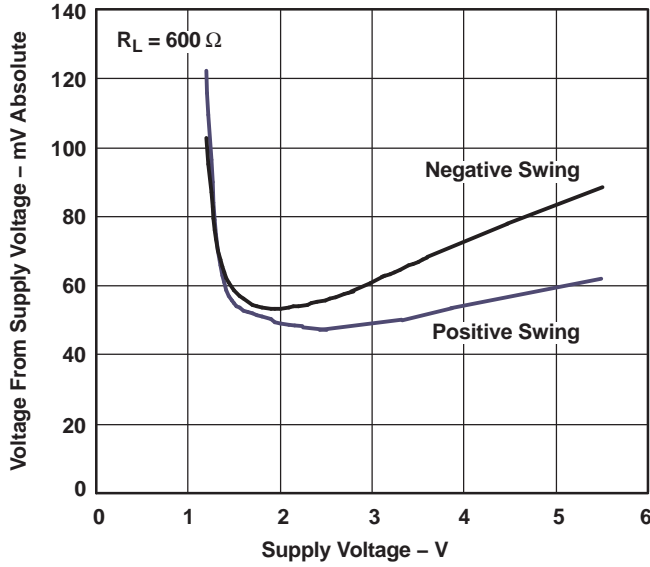

Figure 5.

**OUTPUT VOLTAGE SWING
vs
SUPPLY VOLTAGE**

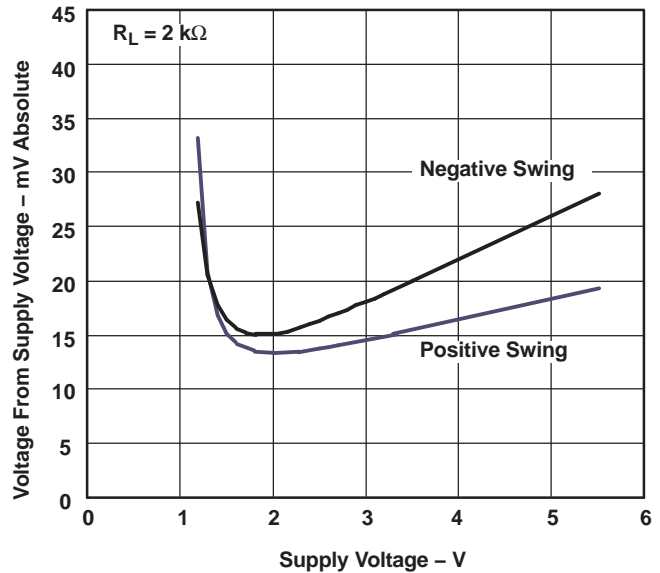

Figure 6.

**SHORT-CIRCUIT CURRENT (SINK)
vs
TEMPERATURE**

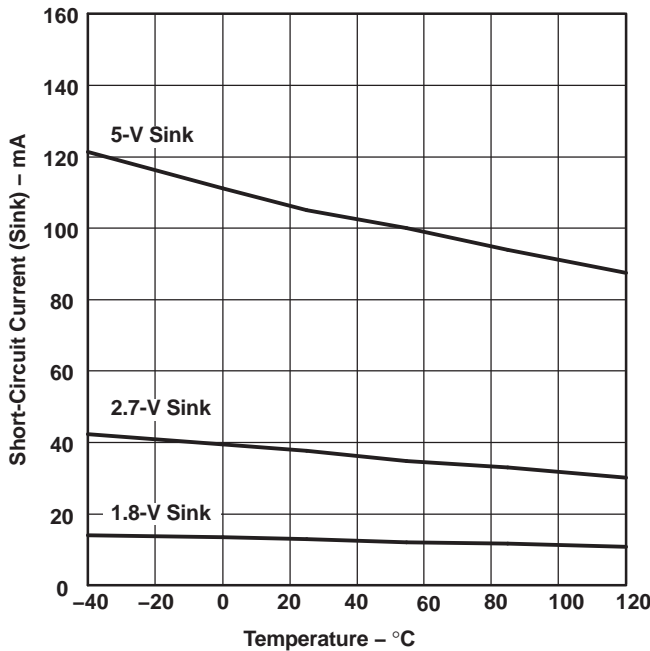

Figure 7.

**SHORT-CIRCUIT CURRENT (SOURCE)
vs
TEMPERATURE**

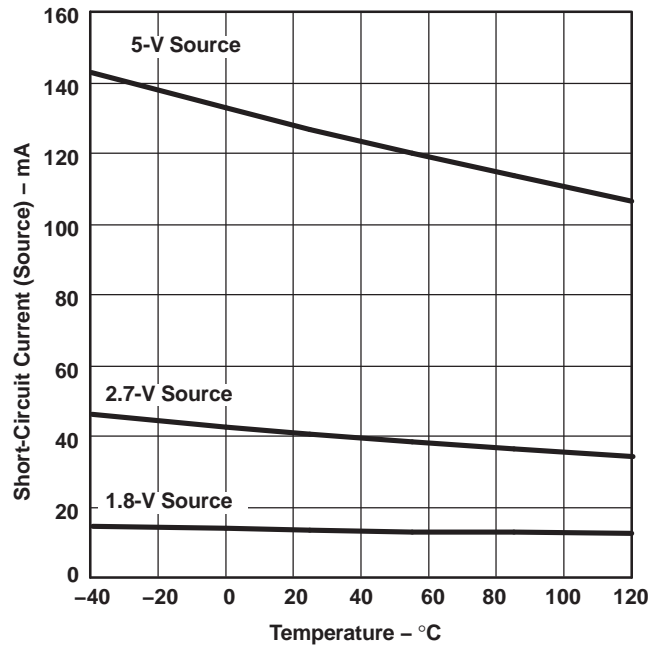

Figure 8.

TYPICAL CHARACTERISTICS (continued)

$V_{CC+} = 5\text{ V}$, Single Supply, $T_A = 25^\circ\text{C}$ (unless otherwise specified)

1.8-V FREQUENCY RESPONSE

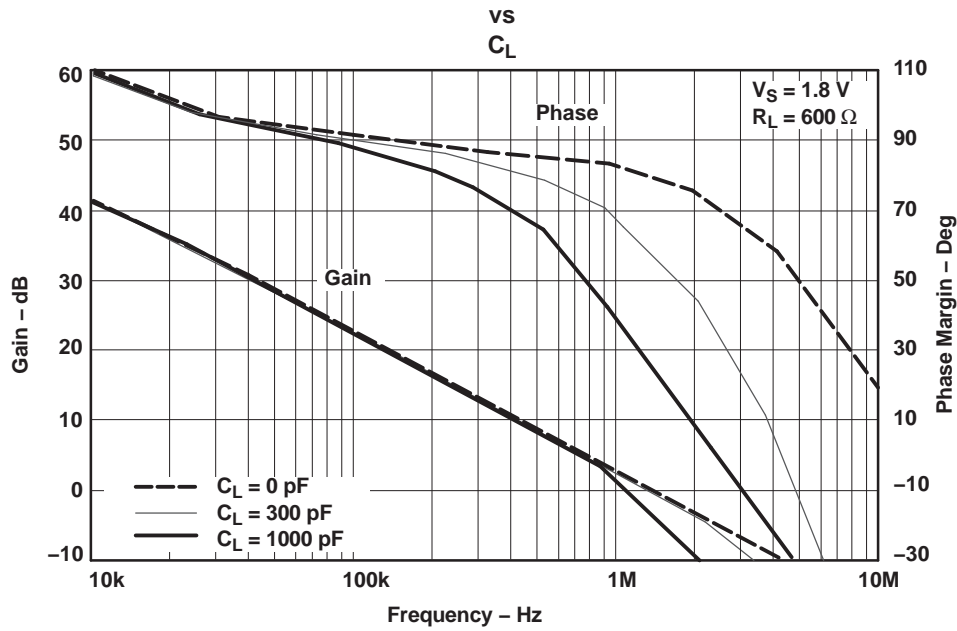

Figure 9.

5-V FREQUENCY RESPONSE

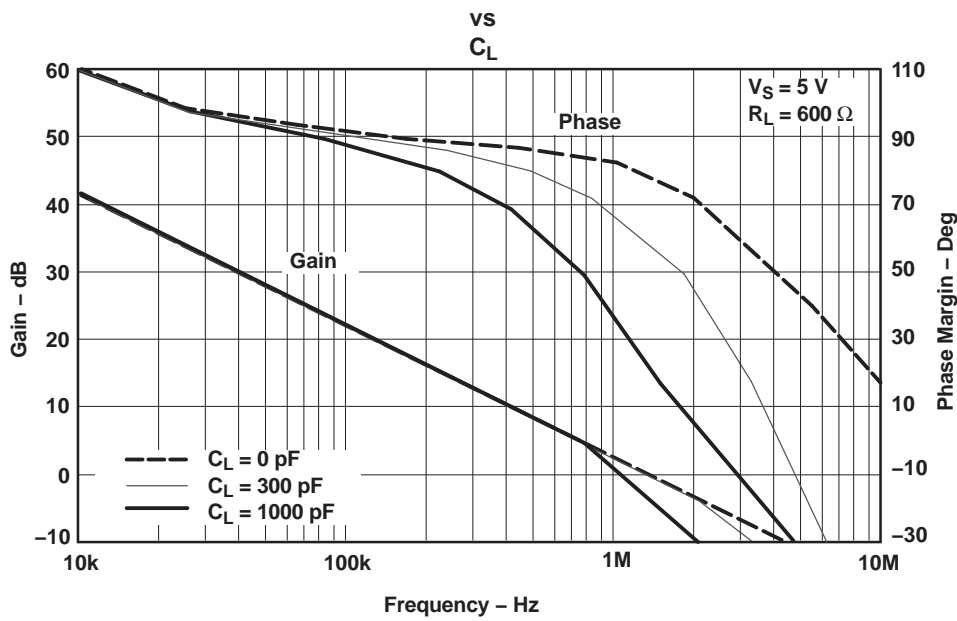

Figure 10.

TYPICAL CHARACTERISTICS (continued)

$V_{CC+} = 5\text{ V}$, Single Supply, $T_A = 25^\circ\text{C}$ (unless otherwise specified)

1.8-V FREQUENCY RESPONSE

vs

TEMPERATURE

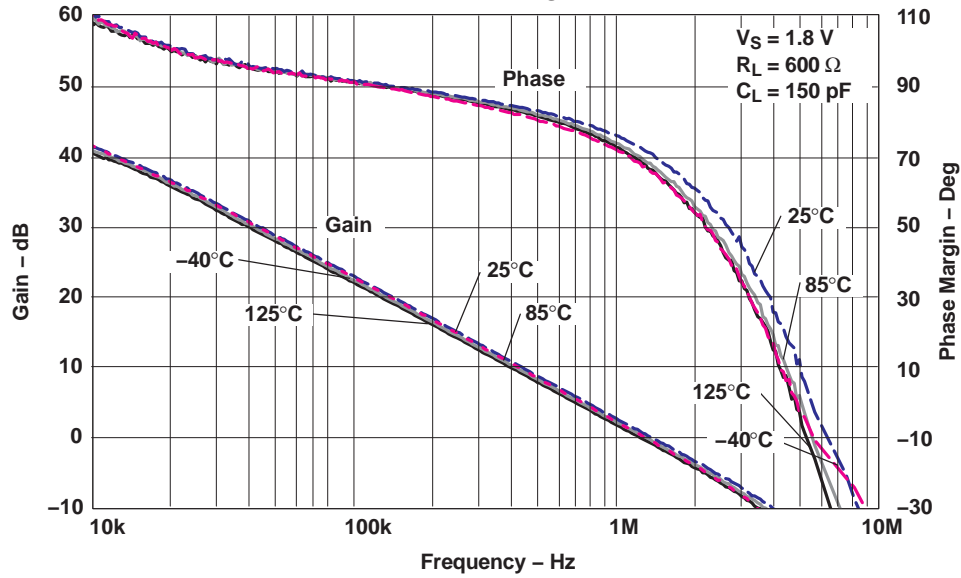

Figure 11.

5-V FREQUENCY RESPONSE

vs

TEMPERATURE

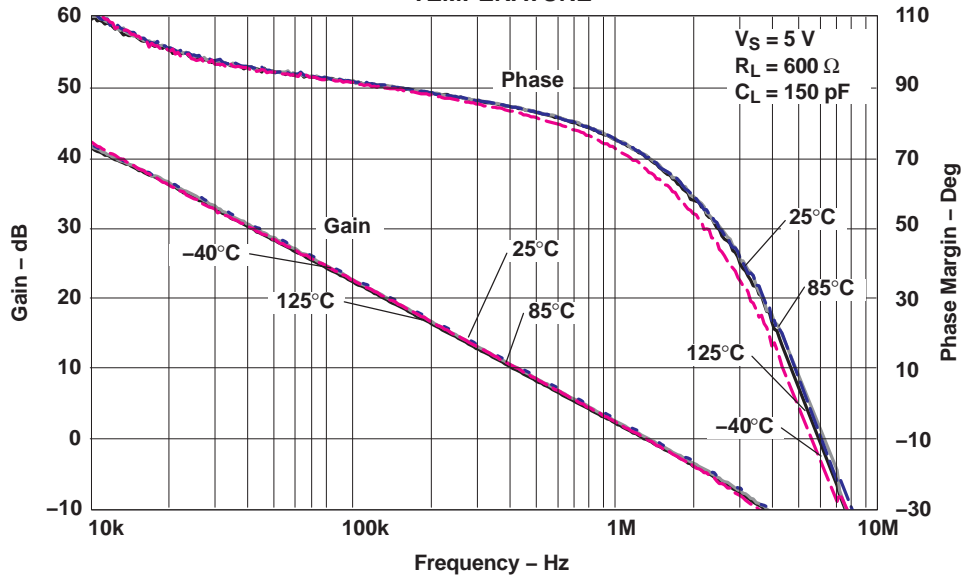

Figure 12.

TYPICAL CHARACTERISTICS (continued)

$V_{CC+} = 5\text{ V}$, Single Supply, $T_A = 25^\circ\text{C}$ (unless otherwise specified)

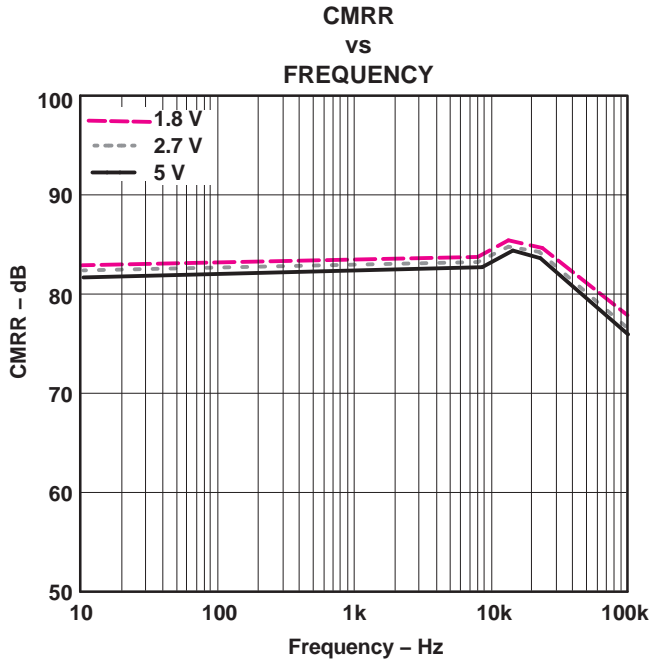

Figure 13.

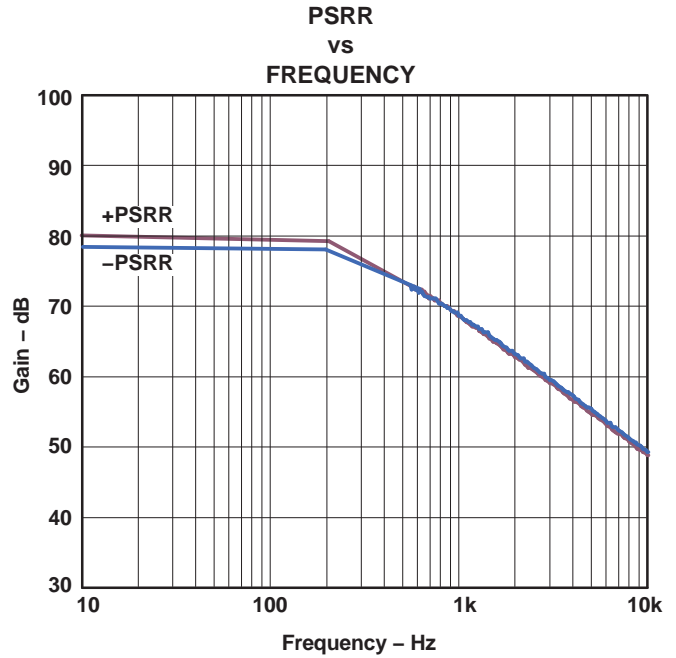

Figure 14.

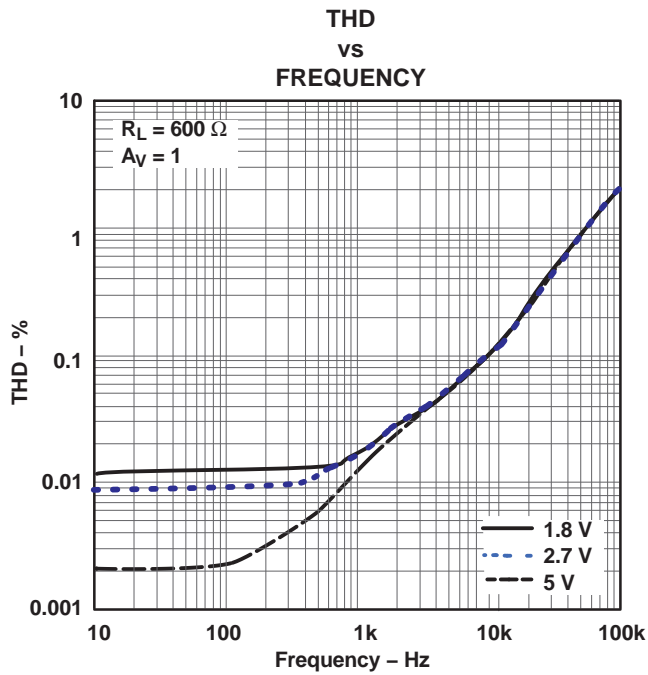

Figure 15.

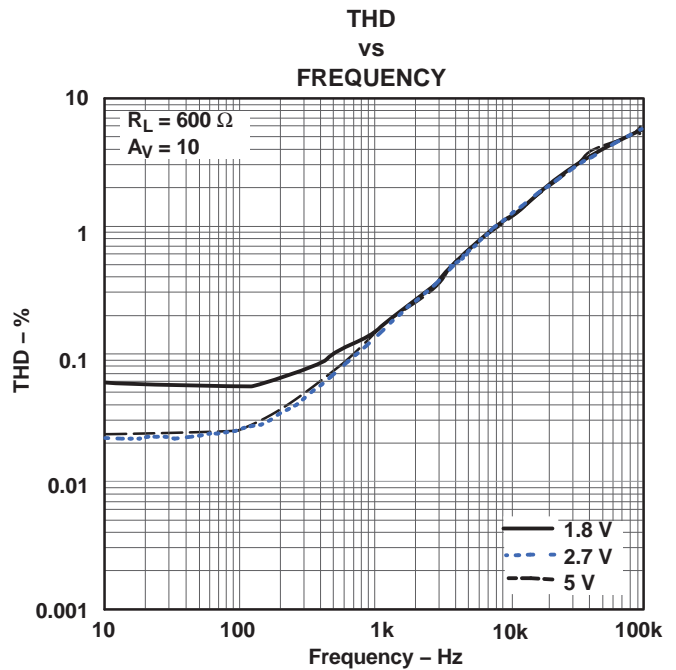

Figure 16.

TYPICAL CHARACTERISTICS (continued)

$V_{CC+} = 5\text{ V}$, Single Supply, $T_A = 25^\circ\text{C}$ (unless otherwise specified)

SMALL-SIGNAL NONINVERTING RESPONSE

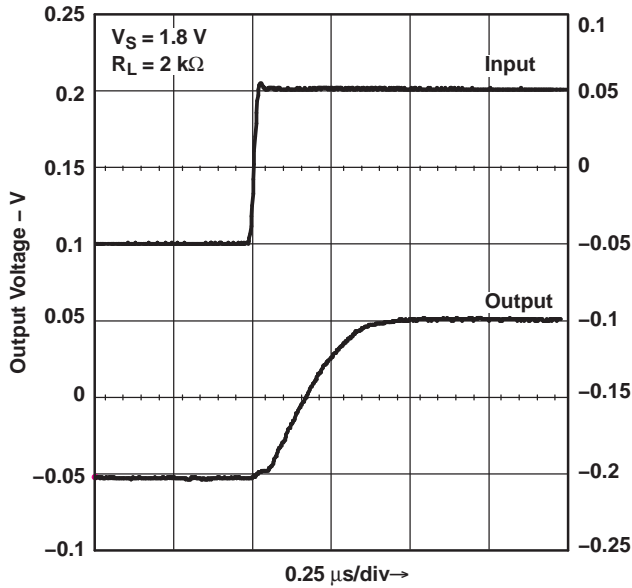

Figure 17.

SMALL-SIGNAL NONINVERTING RESPONSE

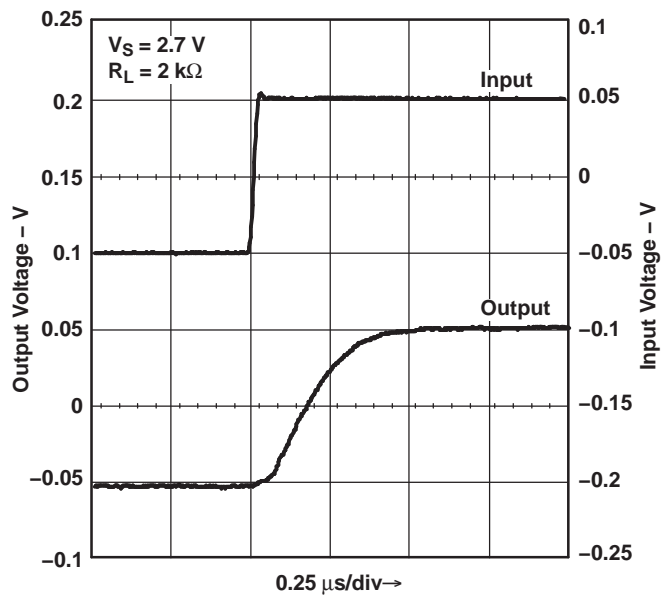

Figure 18.

SMALL-SIGNAL NONINVERTING RESPONSE

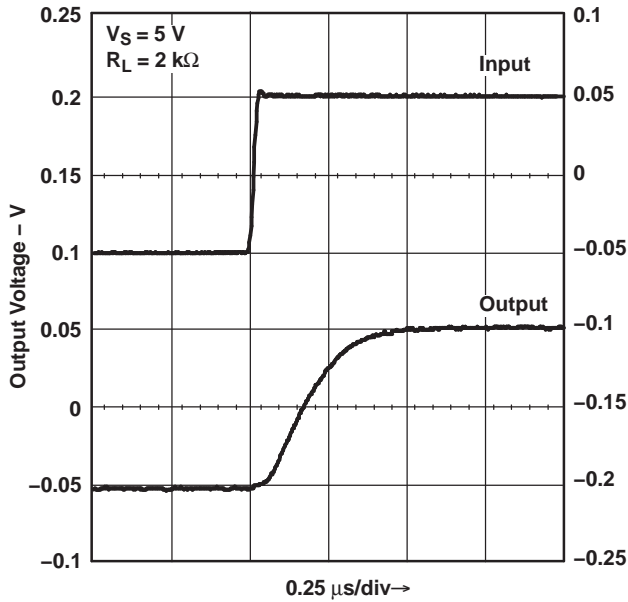

Figure 19.

LARGE-SIGNAL NONINVERTING RESPONSE

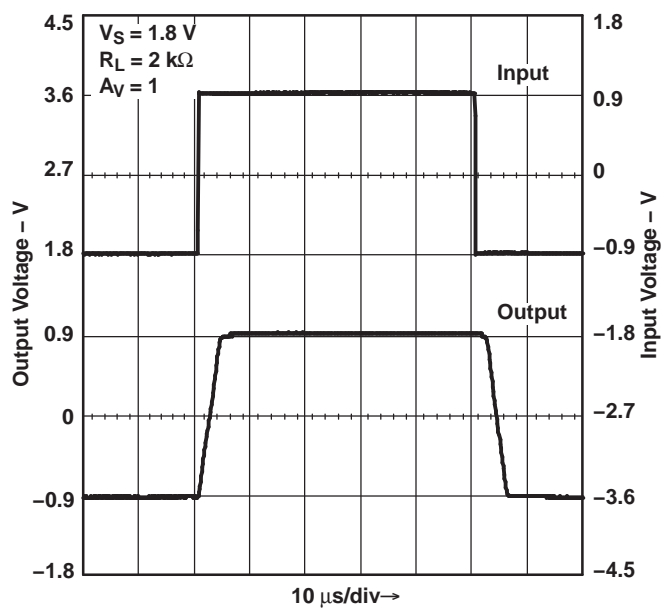

Figure 20.

TYPICAL CHARACTERISTICS (continued)

$V_{CC+} = 5\text{ V}$, Single Supply, $T_A = 25^\circ\text{C}$ (unless otherwise specified)

LARGE-SIGNAL NONINVERTING RESPONSE

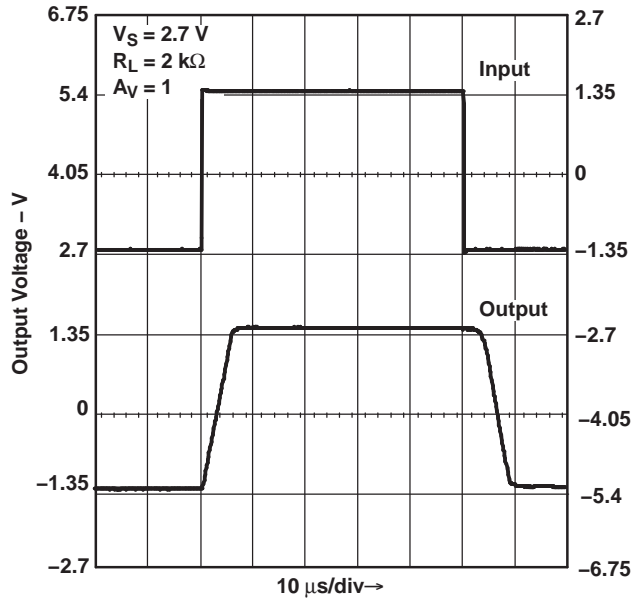

Figure 21.

LARGE-SIGNAL NONINVERTING RESPONSE

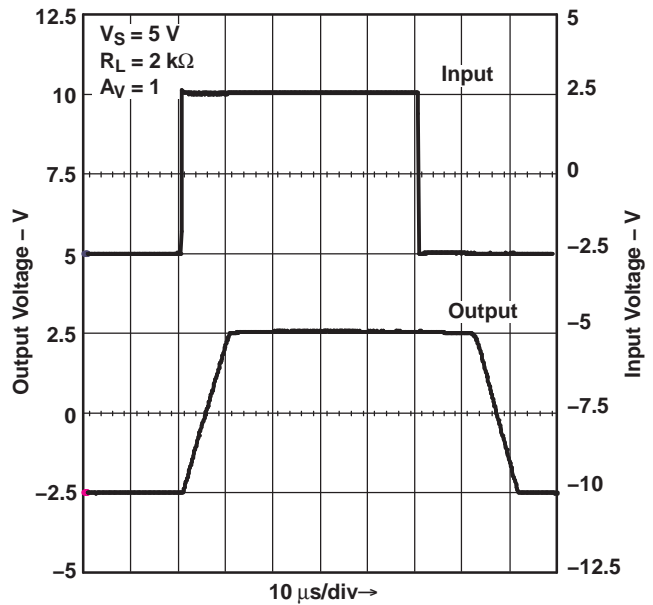

Figure 22.

**OFFSET VOLTAGE
 VS
 COMMON-MODE RANGE**

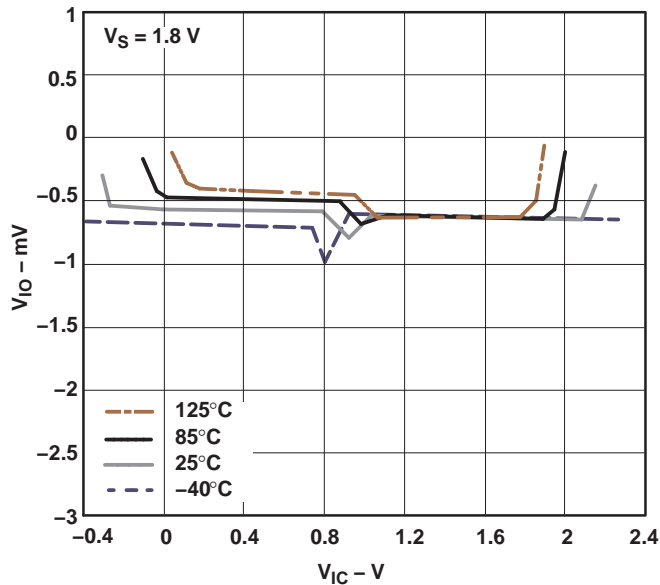

Figure 23.

**OFFSET VOLTAGE
 VS
 COMMON-MODE RANGE**

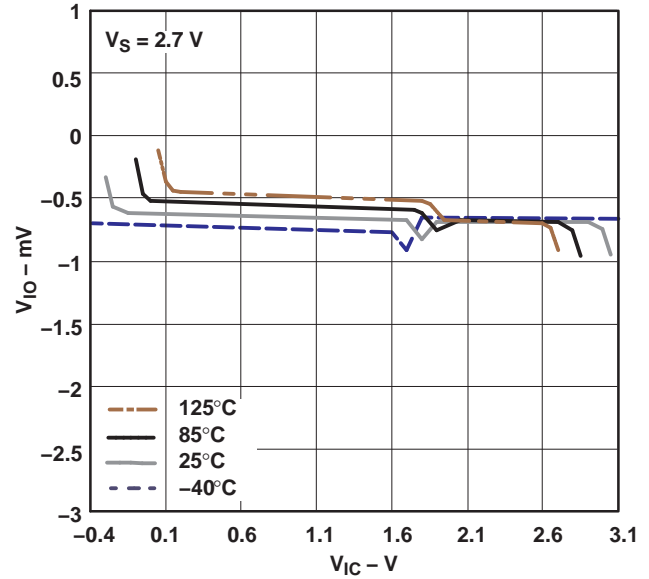

Figure 24.

TYPICAL CHARACTERISTICS (continued)

$V_{CC+} = 5\text{ V}$, Single Supply, $T_A = 25^\circ\text{C}$ (unless otherwise specified)

**OFFSET VOLTAGE
vs
COMMON-MODE RANGE**

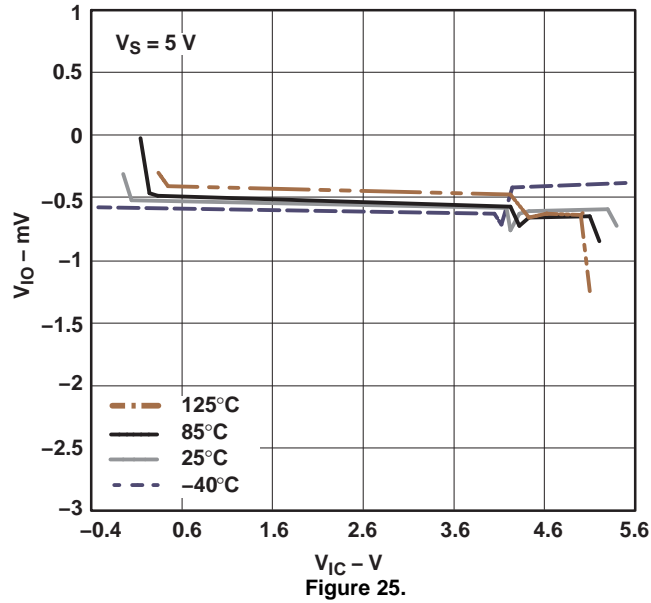

Figure 25.

PACKAGING INFORMATION

Orderable Device	Status ⁽¹⁾	Package Type	Package Drawing	Pins	Package Qty	Eco Plan ⁽²⁾	Lead/ Ball Finish	MSL Peak Temp ⁽³⁾	Samples (Requires Login)
LMV931QDBVRQ1	ACTIVE	SOT-23	DBV	5	3000	Green (RoHS & no Sb/Br)	CU NIPDAU	Level-1-260C-UNLIM	
LMV931QDCKRQ1	ACTIVE	SC70	DCK	5	3000	Green (RoHS & no Sb/Br)	CU NIPDAU	Level-1-260C-UNLIM	
LMV932QDRQ1	ACTIVE	SOIC	D	8	2500	Green (RoHS & no Sb/Br)	CU NIPDAU	Level-1-260C-UNLIM	
LMV934QDRQ1	ACTIVE	SOIC	D	14	2500	Green (RoHS & no Sb/Br)	CU NIPDAU	Level-1-260C-UNLIM	
LMV934QPWRQ1	ACTIVE	TSSOP	PW	14	2000	Green (RoHS & no Sb/Br)	CU NIPDAU	Level-1-260C-UNLIM	

⁽¹⁾ The marketing status values are defined as follows:

ACTIVE: Product device recommended for new designs.

LIFEBUY: TI has announced that the device will be discontinued, and a lifetime-buy period is in effect.

NRND: Not recommended for new designs. Device is in production to support existing customers, but TI does not recommend using this part in a new design.

PREVIEW: Device has been announced but is not in production. Samples may or may not be available.

OBSOLETE: TI has discontinued the production of the device.

⁽²⁾ Eco Plan - The planned eco-friendly classification: Pb-Free (RoHS), Pb-Free (RoHS Exempt), or Green (RoHS & no Sb/Br) - please check <http://www.ti.com/productcontent> for the latest availability information and additional product content details.

TBD: The Pb-Free/Green conversion plan has not been defined.

Pb-Free (RoHS): TI's terms "Lead-Free" or "Pb-Free" mean semiconductor products that are compatible with the current RoHS requirements for all 6 substances, including the requirement that lead not exceed 0.1% by weight in homogeneous materials. Where designed to be soldered at high temperatures, TI Pb-Free products are suitable for use in specified lead-free processes.

Pb-Free (RoHS Exempt): This component has a RoHS exemption for either 1) lead-based flip-chip solder bumps used between the die and package, or 2) lead-based die adhesive used between the die and leadframe. The component is otherwise considered Pb-Free (RoHS compatible) as defined above.

Green (RoHS & no Sb/Br): TI defines "Green" to mean Pb-Free (RoHS compatible), and free of Bromine (Br) and Antimony (Sb) based flame retardants (Br or Sb do not exceed 0.1% by weight in homogeneous material)

⁽³⁾ MSL, Peak Temp. -- The Moisture Sensitivity Level rating according to the JEDEC industry standard classifications, and peak solder temperature.

Important Information and Disclaimer: The information provided on this page represents TI's knowledge and belief as of the date that it is provided. TI bases its knowledge and belief on information provided by third parties, and makes no representation or warranty as to the accuracy of such information. Efforts are underway to better integrate information from third parties. TI has taken and continues to take reasonable steps to provide representative and accurate information but may not have conducted destructive testing or chemical analysis on incoming materials and chemicals. TI and TI suppliers consider certain information to be proprietary, and thus CAS numbers and other limited information may not be available for release.

In no event shall TI's liability arising out of such information exceed the total purchase price of the TI part(s) at issue in this document sold by TI to Customer on an annual basis.

OTHER QUALIFIED VERSIONS OF LMV931-Q1, LMV932-Q1, LMV934-Q1 :

- Catalog: [LMV931](#), [LMV932](#), [LMV934](#)

NOTE: Qualified Version Definitions:

- Catalog - TI's standard catalog product

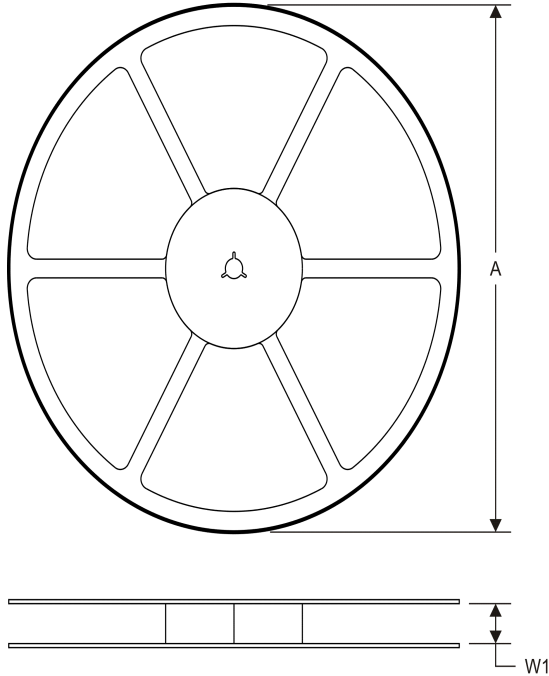
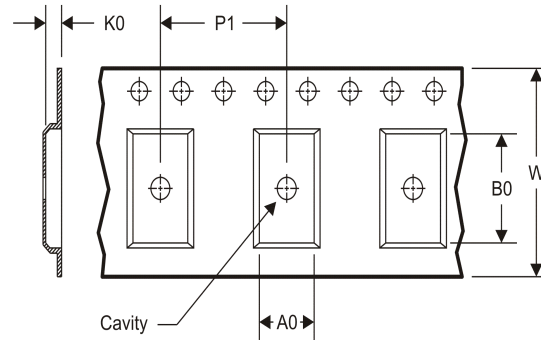
TAPE AND REEL INFORMATION
REEL DIMENSIONS

TAPE DIMENSIONS

A0	Dimension designed to accommodate the component width
B0	Dimension designed to accommodate the component length
K0	Dimension designed to accommodate the component thickness
W	Overall width of the carrier tape
P1	Pitch between successive cavity centers

TAPE AND REEL INFORMATION

*All dimensions are nominal

Device	Package Type	Package Drawing	Pins	SPQ	Reel Diameter (mm)	Reel Width W1 (mm)	A0 (mm)	B0 (mm)	K0 (mm)	P1 (mm)	W (mm)	Pin1 Quadrant
LMV932QDRQ1	SOIC	D	8	2500	330.0	12.4	6.4	5.2	2.1	8.0	12.0	Q1
LMV934QDRQ1	SOIC	D	14	2500	330.0	16.4	6.5	9.0	2.1	8.0	16.0	Q1
LMV934QPWRQ1	TSSOP	PW	14	2000	330.0	12.4	6.9	5.6	1.6	8.0	12.0	Q1

TAPE AND REEL BOX DIMENSIONS

*All dimensions are nominal

Device	Package Type	Package Drawing	Pins	SPQ	Length (mm)	Width (mm)	Height (mm)
LMV932QDRQ1	SOIC	D	8	2500	340.5	338.1	20.6
LMV934QDRQ1	SOIC	D	14	2500	367.0	367.0	38.0
LMV934QPWRQ1	TSSOP	PW	14	2000	367.0	367.0	35.0

DBV (R-PDSO-G5)

PLASTIC SMALL OUTLINE



- NOTES:
- A. All linear dimensions are in millimeters.
 - B. This drawing is subject to change without notice.
 - C. Customers should place a note on the circuit board fabrication drawing not to alter the center solder mask defined pad.
 - D. Publication IPC-7351 is recommended for alternate designs.
 - E. Laser cutting apertures with trapezoidal walls and also rounding corners will offer better paste release. Customers should contact their board assembly site for stencil design recommendations. Example stencil design based on a 50% volumetric metal load solder paste. Refer to IPC-7525 for other stencil recommendations.

DCK (R-PDSO-G5)

PLASTIC SMALL-OUTLINE PACKAGE



- NOTES:
- A. All linear dimensions are in millimeters.
 - B. This drawing is subject to change without notice.
 - C. Body dimensions do not include mold flash or protrusion. Mold flash and protrusion shall not exceed 0.15 per side.
 - D. Falls within JEDEC MO-203 variation AA.

DCK (R-PDSO-G5)

PLASTIC SMALL OUTLINE

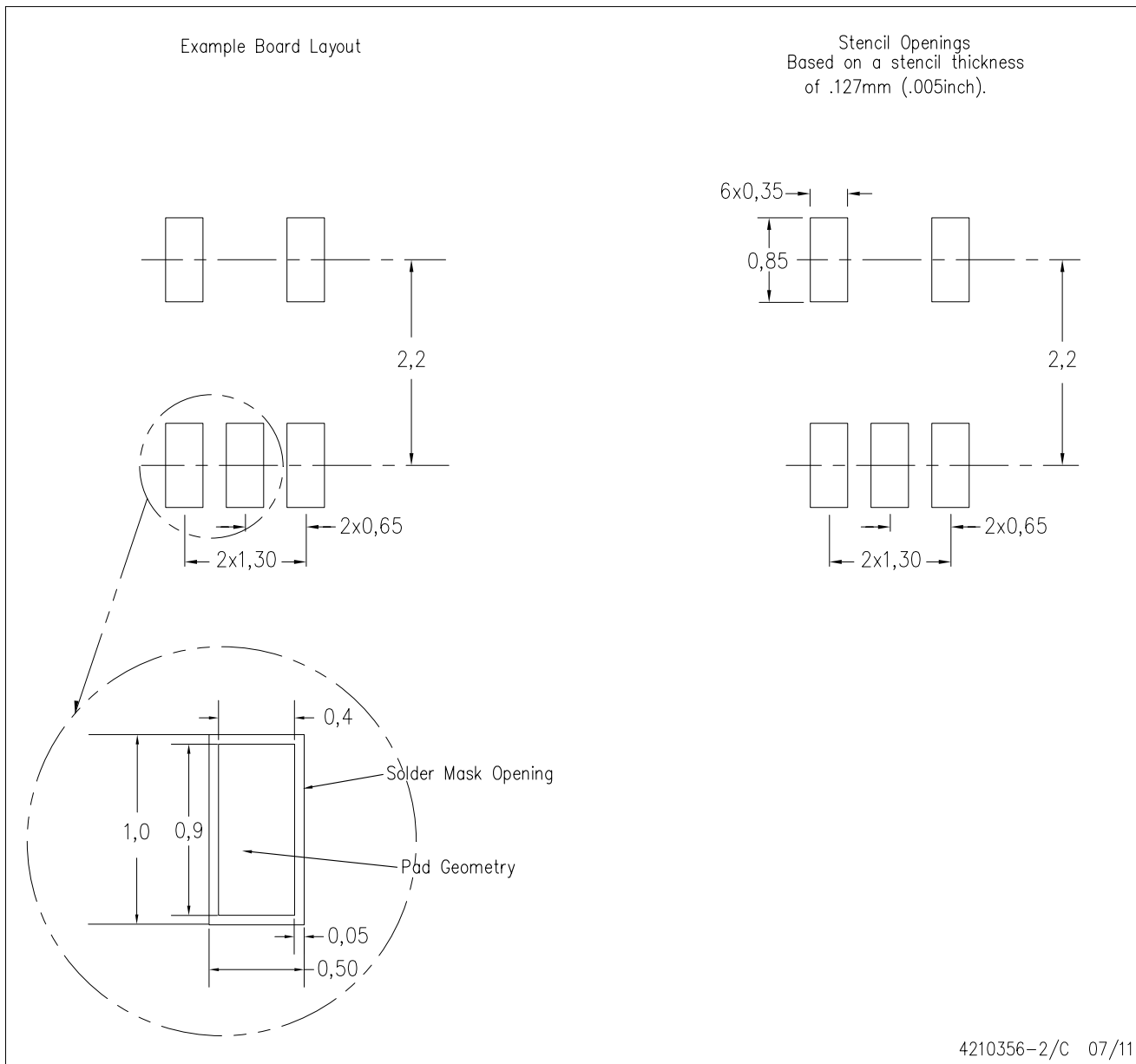

- NOTES:
- All linear dimensions are in millimeters.
 - This drawing is subject to change without notice.
 - Customers should place a note on the circuit board fabrication drawing not to alter the center solder mask defined pad.
 - Publication IPC-7351 is recommended for alternate designs.
 - Laser cutting apertures with trapezoidal walls and also rounding corners will offer better paste release. Customers should contact their board assembly site for stencil design recommendations. Example stencil design based on a 50% volumetric metal load solder paste. Refer to IPC-7525 for other stencil recommendations.

D (R-PDSO-G14)

PLASTIC SMALL OUTLINE



4211283-3/E 08/12

- NOTES:
- All linear dimensions are in millimeters.
 - This drawing is subject to change without notice.
 - Publication IPC-7351 is recommended for alternate designs.
 - Laser cutting apertures with trapezoidal walls and also rounding corners will offer better paste release. Customers should contact their board assembly site for stencil design recommendations. Refer to IPC-7525 for other stencil recommendations.
 - Customers should contact their board fabrication site for solder mask tolerances between and around signal pads.

PW (R-PDSO-G14)

PLASTIC SMALL OUTLINE

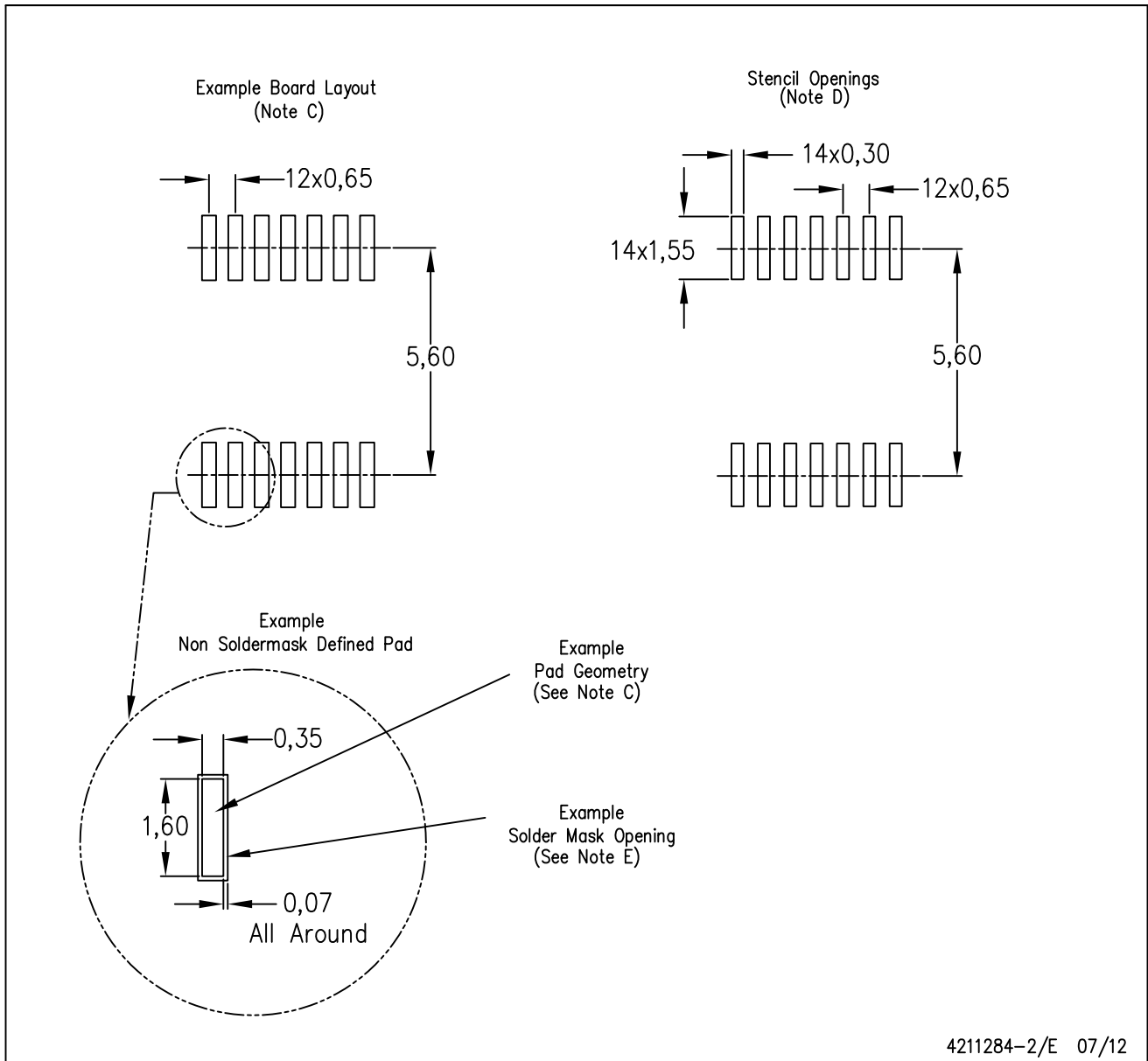

- NOTES:
- All linear dimensions are in millimeters.
 - This drawing is subject to change without notice.
 - Publication IPC-7351 is recommended for alternate designs.
 - Laser cutting apertures with trapezoidal walls and also rounding corners will offer better paste release. Customers should contact their board assembly site for stencil design recommendations. Refer to IPC-7525 for other stencil recommendations.
 - Customers should contact their board fabrication site for solder mask tolerances between and around signal pads.

D (R-PDSO-G8)

PLASTIC SMALL OUTLINE

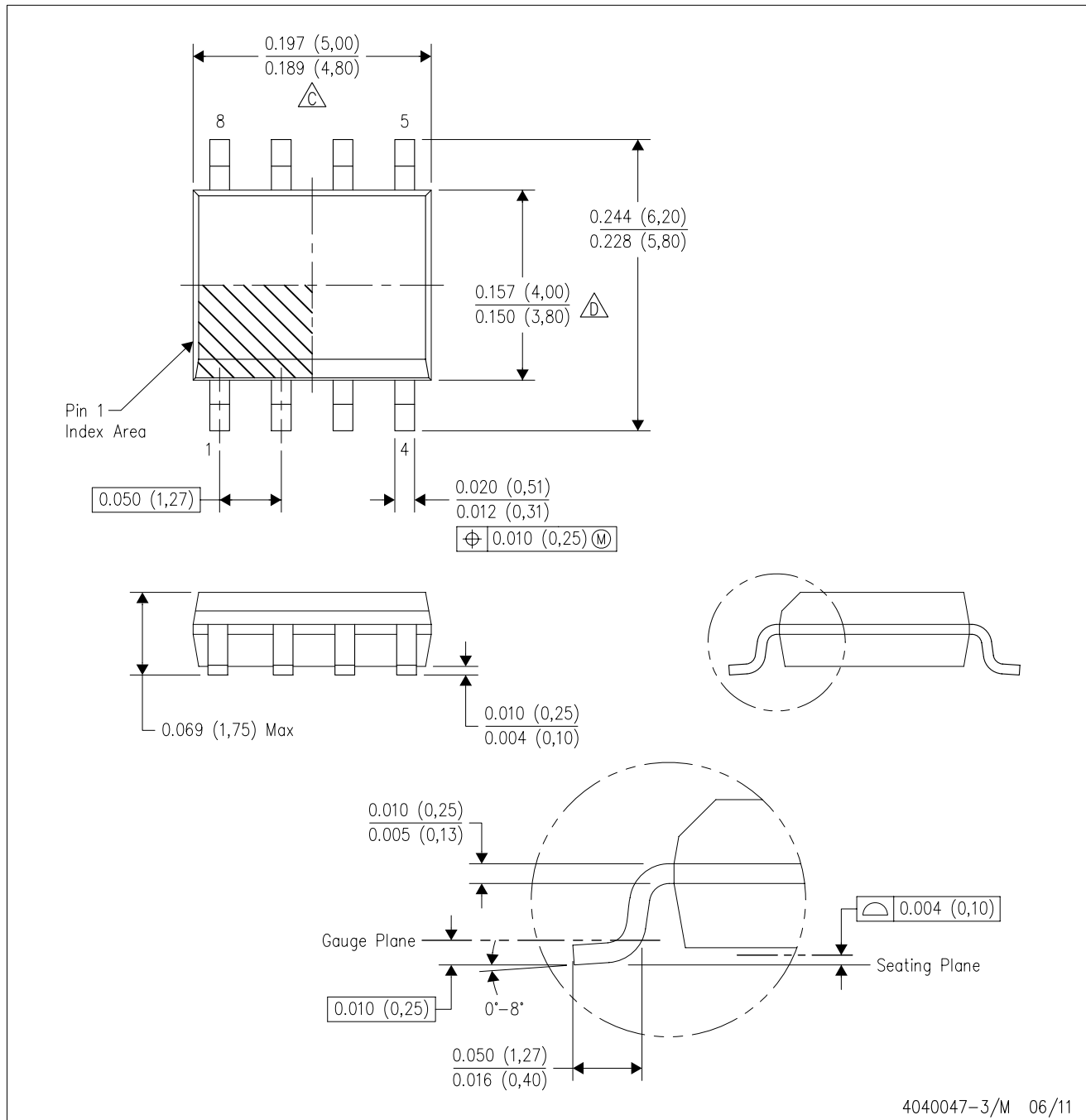

NOTES: A. All linear dimensions are in inches (millimeters).
 B. This drawing is subject to change without notice.
 C. Body length does not include mold flash, protrusions, or gate burrs. Mold flash, protrusions, or gate burrs shall not exceed 0.006 (0,15) each side.
 D. Body width does not include interlead flash. Interlead flash shall not exceed 0.017 (0,43) each side.
 E. Reference JEDEC MS-012 variation AA.

D (R-PDSO-G8)

PLASTIC SMALL OUTLINE

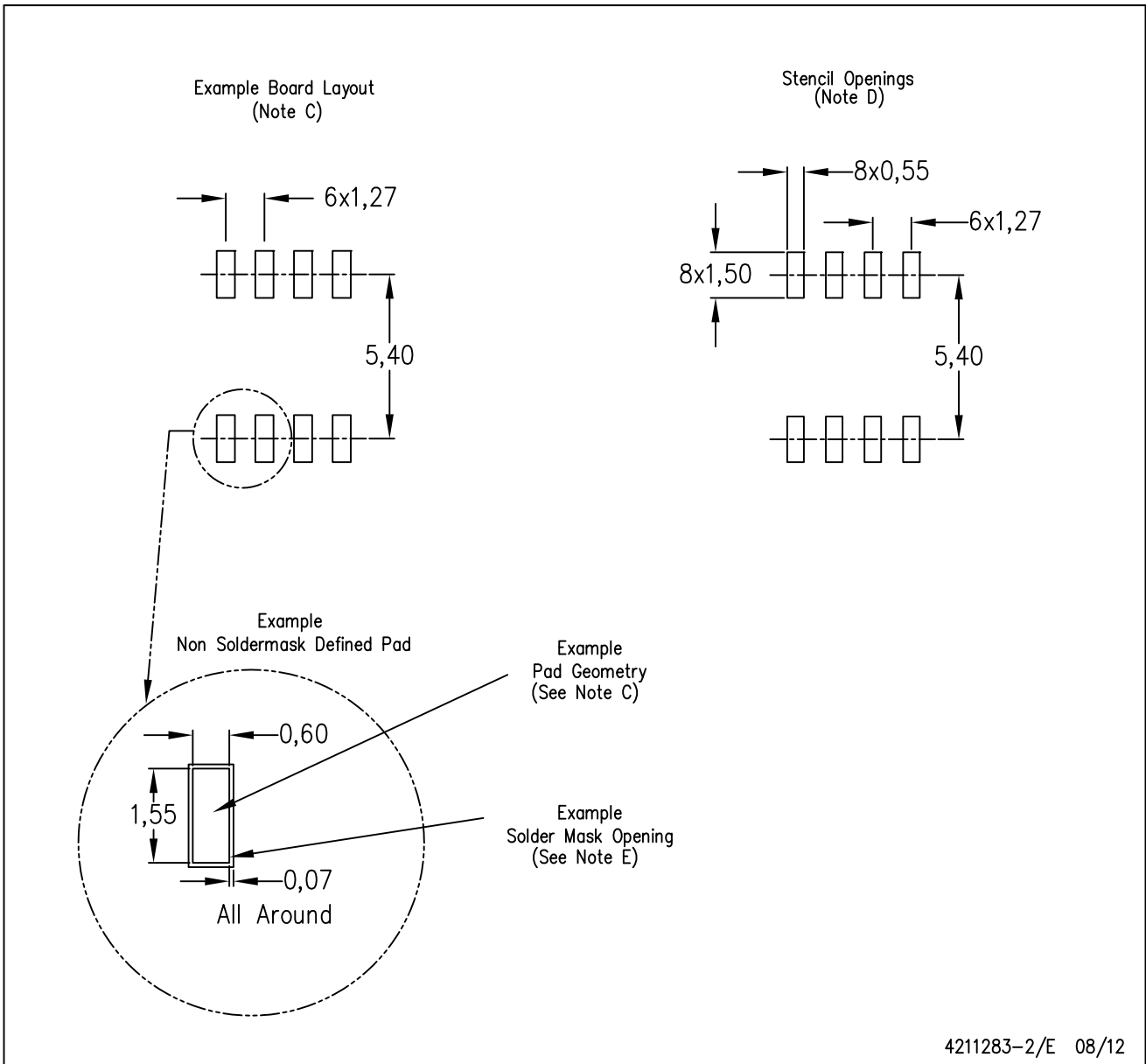

- NOTES:
- A. All linear dimensions are in millimeters.
 - B. This drawing is subject to change without notice.
 - C. Publication IPC-7351 is recommended for alternate designs.
 - D. Laser cutting apertures with trapezoidal walls and also rounding corners will offer better paste release. Customers should contact their board assembly site for stencil design recommendations. Refer to IPC-7525 for other stencil recommendations.
 - E. Customers should contact their board fabrication site for solder mask tolerances between and around signal pads.

IMPORTANT NOTICE

Texas Instruments Incorporated and its subsidiaries (TI) reserve the right to make corrections, enhancements, improvements and other changes to its semiconductor products and services per JESD46, latest issue, and to discontinue any product or service per JESD48, latest issue. Buyers should obtain the latest relevant information before placing orders and should verify that such information is current and complete. All semiconductor products (also referred to herein as "components") are sold subject to TI's terms and conditions of sale supplied at the time of order acknowledgment.

TI warrants performance of its components to the specifications applicable at the time of sale, in accordance with the warranty in TI's terms and conditions of sale of semiconductor products. Testing and other quality control techniques are used to the extent TI deems necessary to support this warranty. Except where mandated by applicable law, testing of all parameters of each component is not necessarily performed.

TI assumes no liability for applications assistance or the design of Buyers' products. Buyers are responsible for their products and applications using TI components. To minimize the risks associated with Buyers' products and applications, Buyers should provide adequate design and operating safeguards.

TI does not warrant or represent that any license, either express or implied, is granted under any patent right, copyright, mask work right, or other intellectual property right relating to any combination, machine, or process in which TI components or services are used. Information published by TI regarding third-party products or services does not constitute a license to use such products or services or a warranty or endorsement thereof. Use of such information may require a license from a third party under the patents or other intellectual property of the third party, or a license from TI under the patents or other intellectual property of TI.

Reproduction of significant portions of TI information in TI data books or data sheets is permissible only if reproduction is without alteration and is accompanied by all associated warranties, conditions, limitations, and notices. TI is not responsible or liable for such altered documentation. Information of third parties may be subject to additional restrictions.

Resale of TI components or services with statements different from or beyond the parameters stated by TI for that component or service voids all express and any implied warranties for the associated TI component or service and is an unfair and deceptive business practice. TI is not responsible or liable for any such statements.

Buyer acknowledges and agrees that it is solely responsible for compliance with all legal, regulatory and safety-related requirements concerning its products, and any use of TI components in its applications, notwithstanding any applications-related information or support that may be provided by TI. Buyer represents and agrees that it has all the necessary expertise to create and implement safeguards which anticipate dangerous consequences of failures, monitor failures and their consequences, lessen the likelihood of failures that might cause harm and take appropriate remedial actions. Buyer will fully indemnify TI and its representatives against any damages arising out of the use of any TI components in safety-critical applications.

In some cases, TI components may be promoted specifically to facilitate safety-related applications. With such components, TI's goal is to help enable customers to design and create their own end-product solutions that meet applicable functional safety standards and requirements. Nonetheless, such components are subject to these terms.

No TI components are authorized for use in FDA Class III (or similar life-critical medical equipment) unless authorized officers of the parties have executed a special agreement specifically governing such use.

Only those TI components which TI has specifically designated as military grade or "enhanced plastic" are designed and intended for use in military/aerospace applications or environments. Buyer acknowledges and agrees that any military or aerospace use of TI components which have **not** been so designated is solely at the Buyer's risk, and that Buyer is solely responsible for compliance with all legal and regulatory requirements in connection with such use.

TI has specifically designated certain components which meet ISO/TS16949 requirements, mainly for automotive use. Components which have not been so designated are neither designed nor intended for automotive use; and TI will not be responsible for any failure of such components to meet such requirements.

Products

Audio	www.ti.com/audio
Amplifiers	amplifier.ti.com
Data Converters	dataconverter.ti.com
DLP® Products	www.dlp.com
DSP	dsp.ti.com
Clocks and Timers	www.ti.com/clocks
Interface	interface.ti.com
Logic	logic.ti.com
Power Mgmt	power.ti.com
Microcontrollers	microcontroller.ti.com
RFID	www.ti-rfid.com
OMAP Applications Processors	www.ti.com/omap
Wireless Connectivity	www.ti.com/wirelessconnectivity

Applications

Automotive and Transportation	www.ti.com/automotive
Communications and Telecom	www.ti.com/communications
Computers and Peripherals	www.ti.com/computers
Consumer Electronics	www.ti.com/consumer-apps
Energy and Lighting	www.ti.com/energy
Industrial	www.ti.com/industrial
Medical	www.ti.com/medical
Security	www.ti.com/security
Space, Avionics and Defense	www.ti.com/space-avionics-defense
Video and Imaging	www.ti.com/video

TI E2E Community

e2e.ti.com